

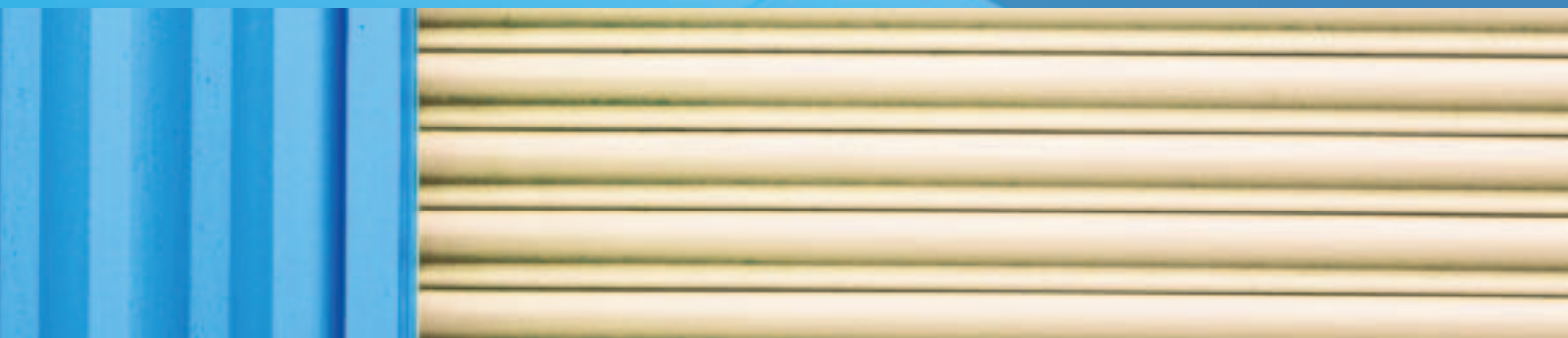

STEEL SHUTTER CATALOGUE



一般開口部には0.8mmタイプ
大開口には1.2mmタイプ
文化ベトナムから発売。

0.8mm type is suitable for the
standard shutter size.

1.2mm type is suitable for the
big shutter size.



○ 0.8mmスラット仕様
0.8mm slat type

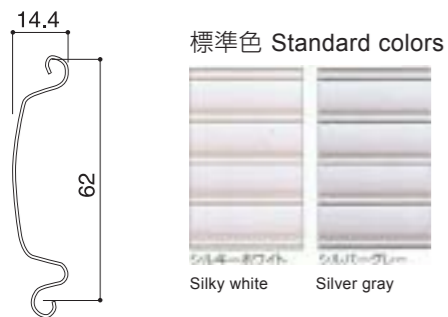

スラットには、0.8mmの溶融亜鉛メッキをロール成形したものを
使用します。一般的な大きさの開口部に最適です。

0.8mm heated zinc coated steel is used by slats creating
wave shape. To be suitable for standard opening size.

○ 1.2mmスラット仕様
1.2mm slat type

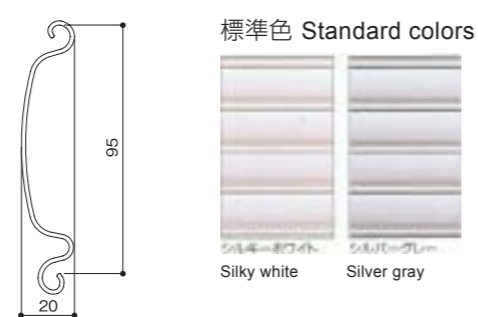

スラットには、1.2mmの溶融亜鉛メッキをロール成形したものを
使用します。大きな開口部に最適です。

1.2mm heated zinc coated steel is used by slats creating
wave shape. To be suitable for big opening size.

○ 耐風型とは… Wind Proof

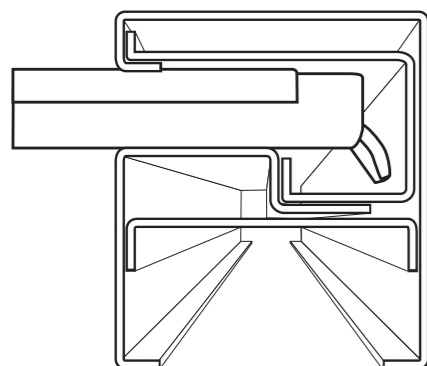

スラットの両端に爪状の金具を取り付け、サイドレールに爪のひ
っかけりを設けることにより、強風でスラットがレールより脱出す
ることを防ぎます。

Windproof is designed with 2 hooks at slat both ends are con-
nected with the guide rail to against the strong wind. Slats will
not be slipped out of the guide rail when wind is strong.

○ 0.8mmスラット仕様 参考図 0.8mm slat specifications reference drawing

内部専用参考図 Internal use drawing

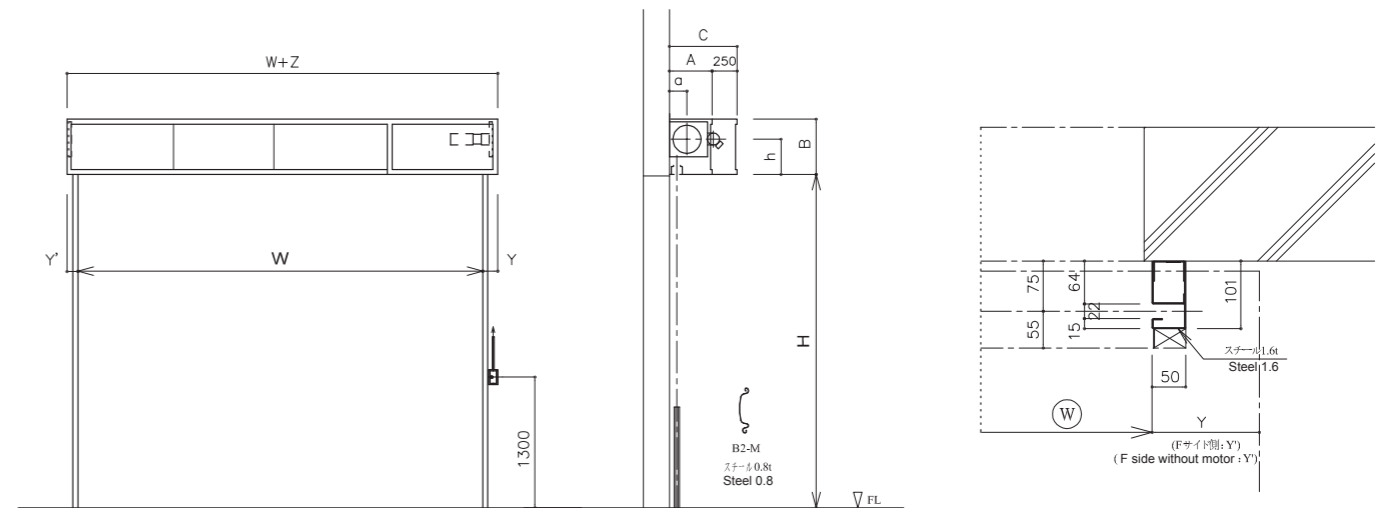
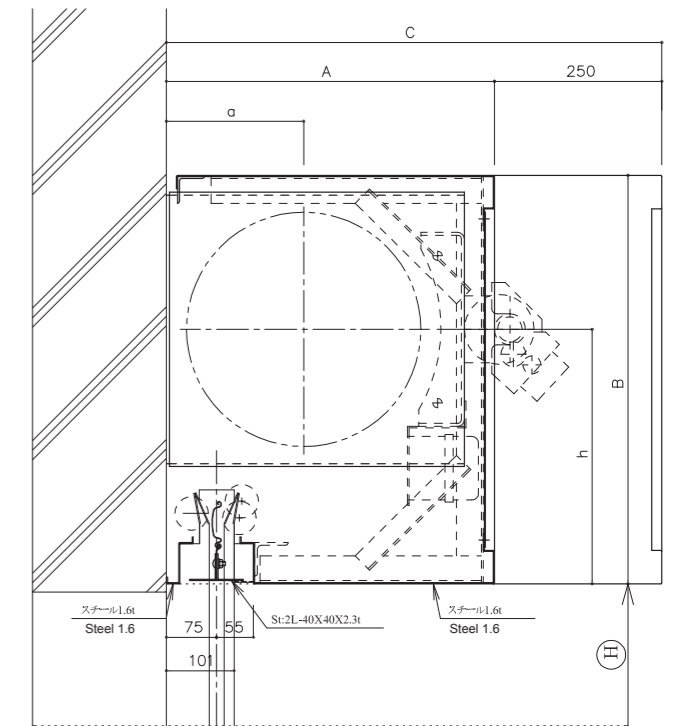
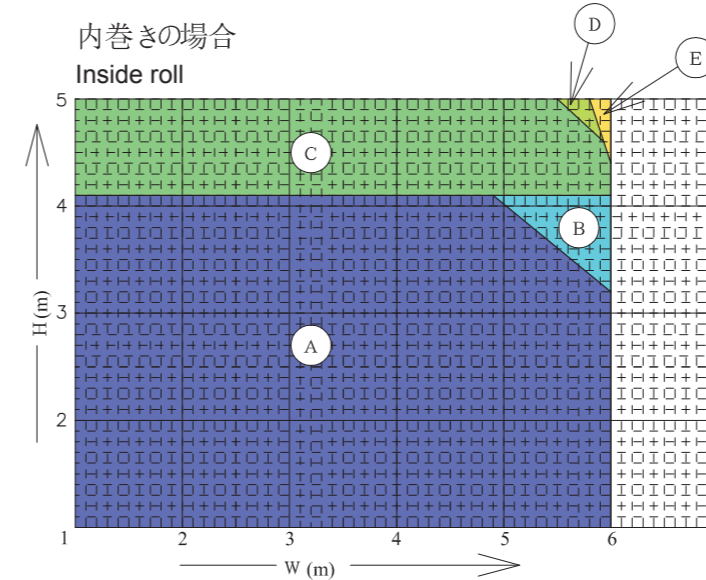

範囲 Range	開閉機 Motor	巻取り Shaft	ブラケット Bracket	a	b	h	角ケース Shutter hood		
							A	B	C
A	EGR - 30X	4B - 30	BR - 175 - 35	175	350	350	425	550	675
B	EGR - 30X	4B - 35	BR - 175 - 35	175	350	350	425	550	675
C	EGR - 30X	4B - 35	BR - 205 - 35	205	410	380	490	610	740
D	EGR - 50X	4B - 40	BR - 205 - 40	205	410	380	490	610	740
E	EGR - 50X	5B - 40	BR - 205 - 40	205	410	380	490	610	740

開閉機 Motor	Y・Y'・Z
EGR - 30X EGR - 50X	Y= Y1+ 15
	Y'= Y1'+ 15
	Z= Z1+ 30

○ 0.8mmスラット仕様 参考図 0.8mm slat specifications reference drawing

外部専用参考図 External use drawing

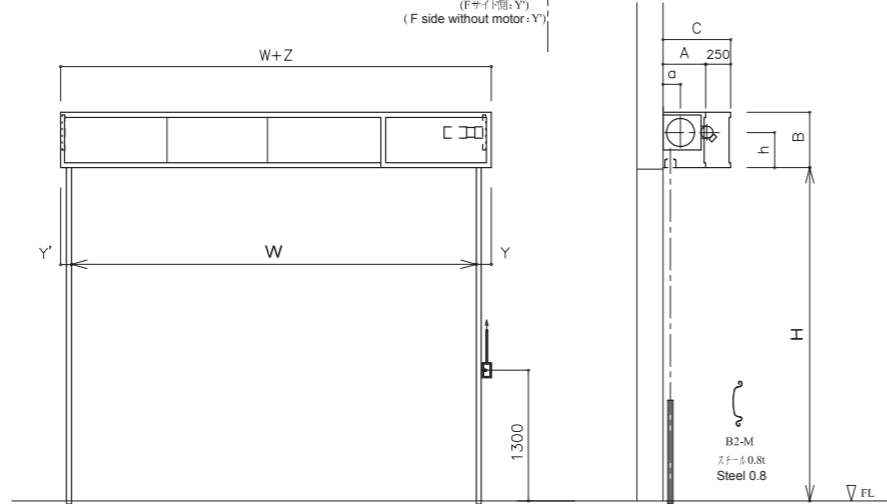
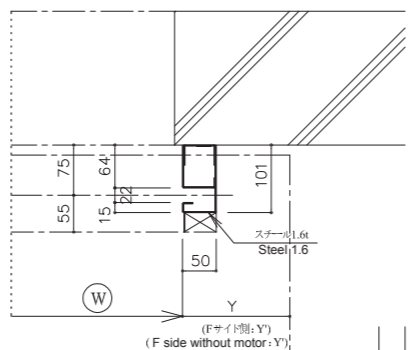
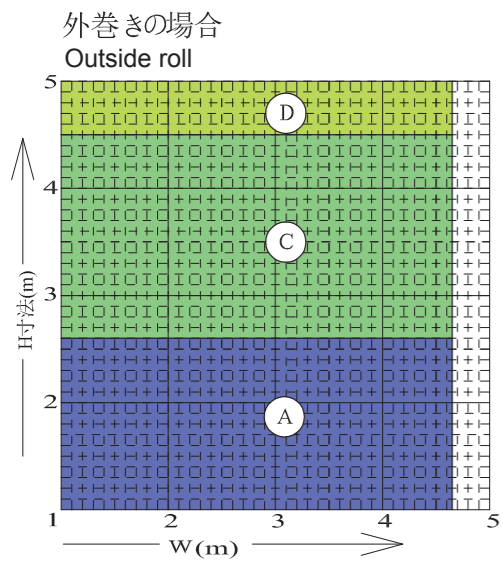
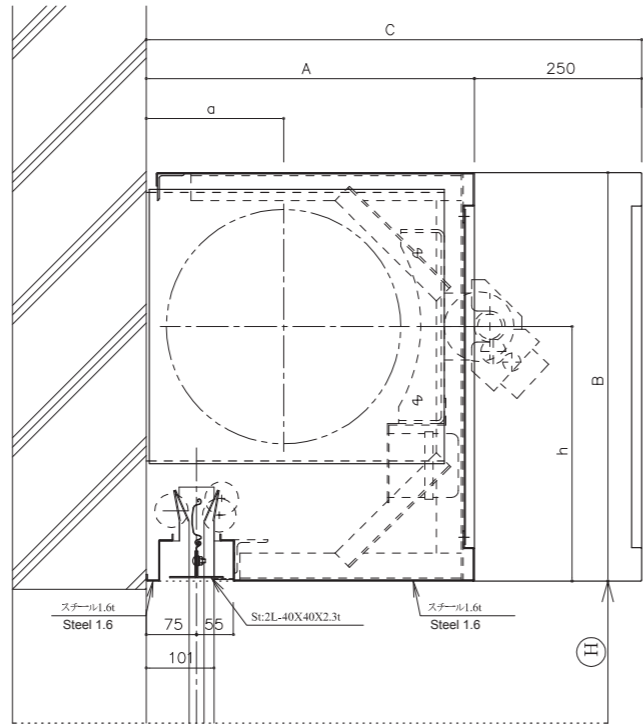
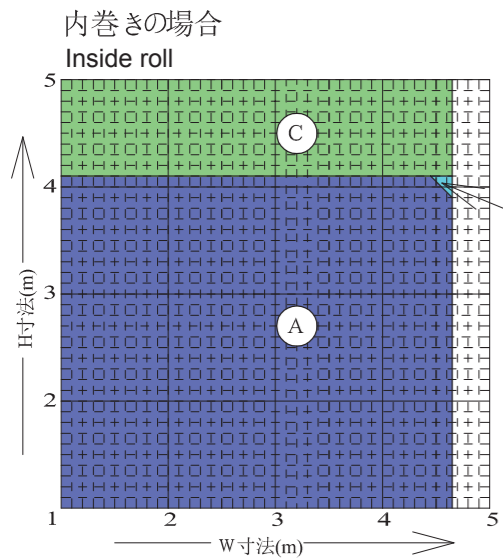

開閉機 Motor	Y・Y'・Z
EGR-30X	Y = Y1 + 15
	Y' = Y1' + 15
	Z = Z1 + 30

範囲 Range	開閉機 Motor	巻取り Shaft	ブラケット Bracket	a	b	h	角ケース Shutter hood		
							A	B	C
A	EGR-30X	4B-35	BR-175-35	175	350	350	425	550	675
B	EGR-30X	4B-35	BR-175-35	175	350	350	425	550	675
C	EGR-30X	4B-35	BR-205-35	205	410	380	490	610	740
D	EGR-30X	4B-35	BR-235-35	235	470	410	575	675	825

○ 1.2mmスラット仕様 参考図 1.2mm slat specifications reference drawing

内部専用参考図 Internal use drawing

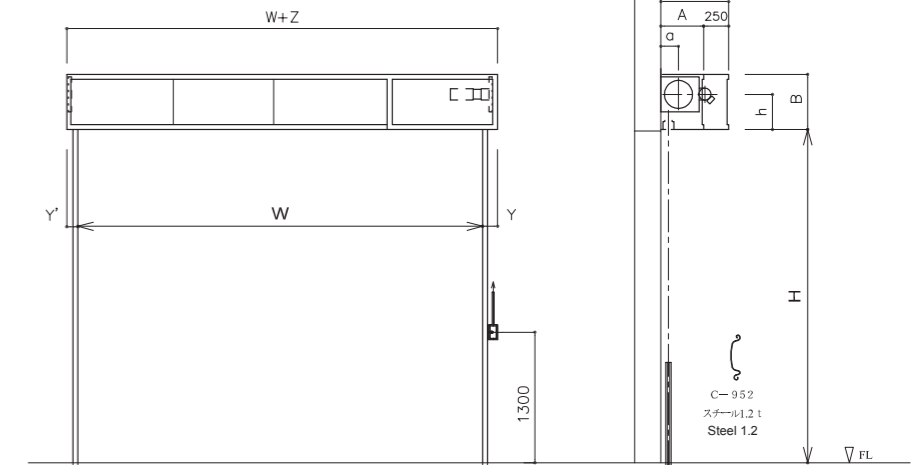
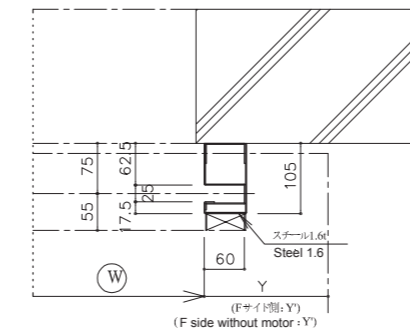
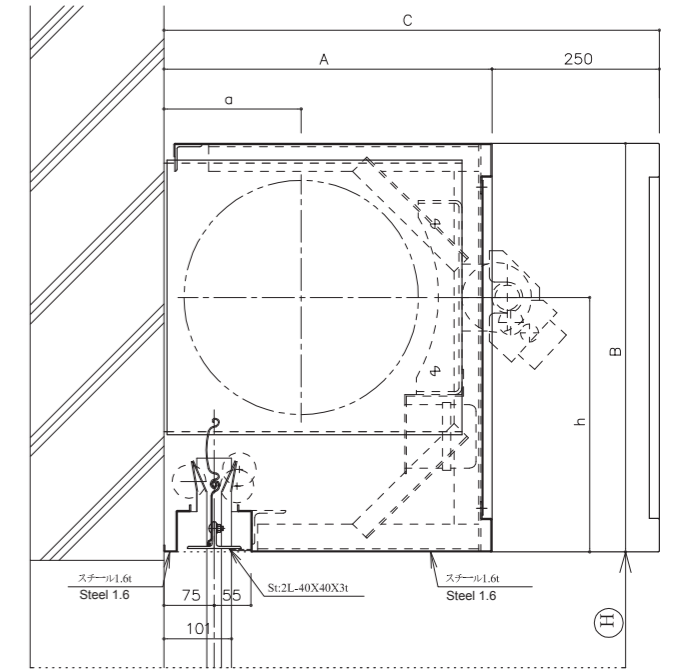
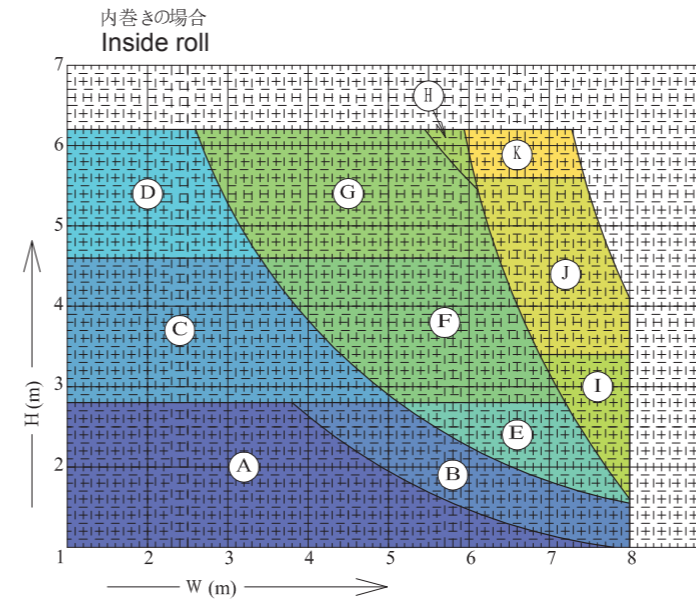

最大開口 Slat type	内部使用の場合 Internal use case
	標準型 Standard rail
C-952	8.0m

C-952スラット開閉機適用表 (1)

C-952 Slat motor using table (1)

範囲 Range	開閉機 Motor	巻取りシャフト Shaft	ブラケット Bracket	共通 Common			角ケース Shutter hood					
				a	b	h	A	B	C	60レール W<=60		
										Y	Y'	Z
A	EGR-30X	5B-30	BR-175-35	175	350	375	425	575	675	160	120	280
B	EGR-30X	5B-35	BR-175-35	175	350	375	425	575	675	170	120	290
C	EGR-30X	5B-35	BR-205-35	205	410	405	490	635	740	170	120	290
D	EGR-30X	5B-35	BR-235-35	235	470	435	575	700	825	170	120	290
E	EGR-50X	5B-40	BR-175-40	175	350	375	425	575	675	185	125	310
F	EGR-50X	5B-40	BR-205-40	205	410	380	490	610	740	185	125	310
G	EGR-50X	5B-40	BR-235-40	235	470	435	575	700	825	185	125	310
H	EGR-70X	5B-45	BR-235-45	235	470	410	515	645	724	185	125	310
I	EGR-70X	6B-45	BR-205-45	205	410	380	490	610	740	185	125	310
J	EGR-70X	6B-45	BR-235-45	235	470	515	575	675	825	185	125	310
K	EGR-70X	6B-45	BR-265-45	265	530	440	635	735	885	185	125	310

○ 1.2mmスラット仕様 参考図 1.2mm slat specifications reference drawing

外部専用参考図 External use drawing

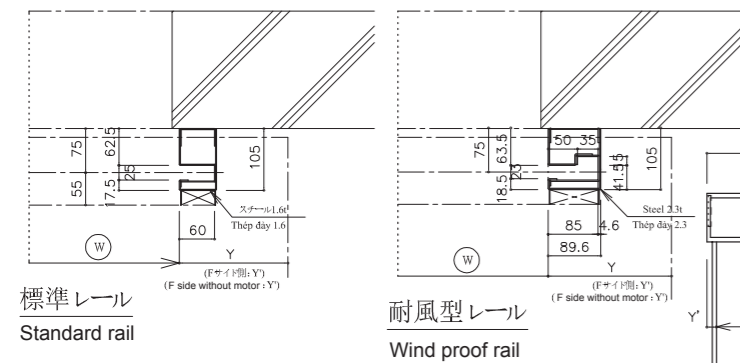
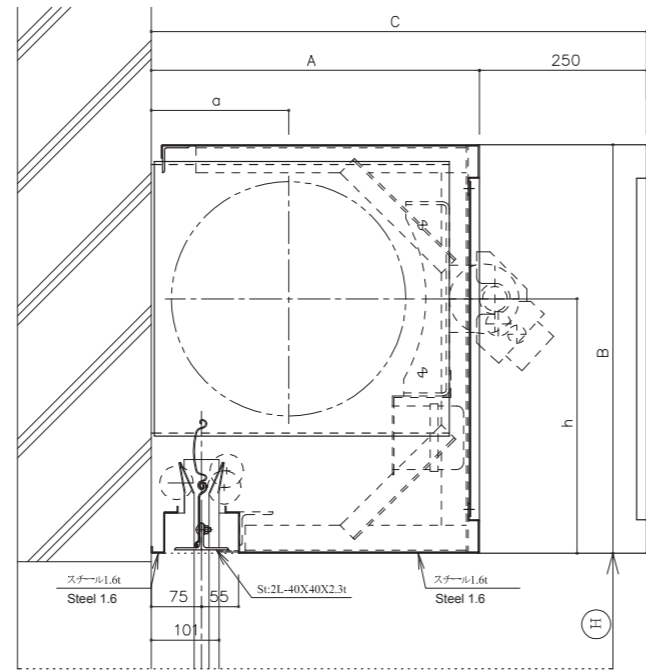
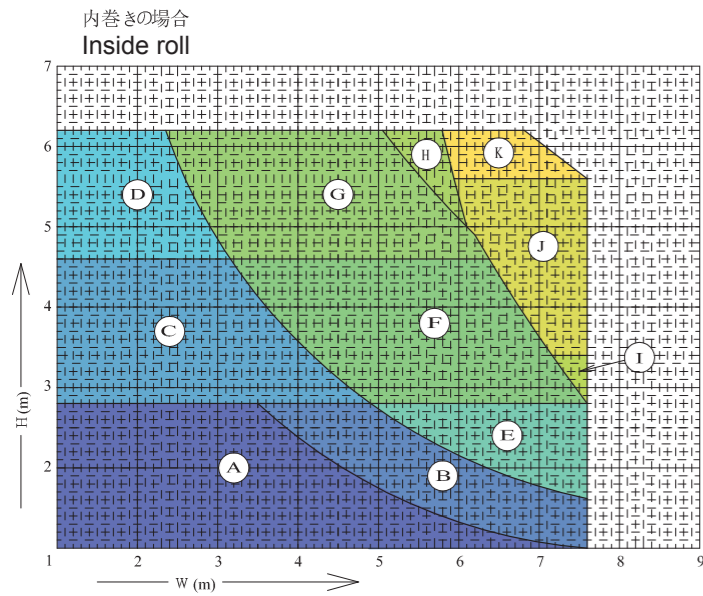

最大開口 Slat type	外部に面する場合 External use case	
	標準型 Standard rail	耐風型 Wind proof rail
C-952	5.0m	7.5m

C-952スラット開閉機適用表 (1)

C-952 Slat motor using table (1)

範囲 Range	開閉機 Motor	巻取リシャフト Shaft	ブラケット Bracket	共通 Common		角ケース Shutter hood									
				a	b	h	A	B	C	60レール W ≤ 60			耐風型 Wind proof rail		
										Y	Y'	Z	Y	Y'	Z
A	EGR-30X	5B-30	BR-175-35	175	350	375	425	575	675	160	120	280	185	145	330
B	EGR-30X	5B-35	BR-175-35	175	350	375	425	575	675	170	120	290	195	145	340
C	EGR-30X	5B-35	BR-205-35	205	410	405	490	635	740	170	120	290	195	145	340
D	EGR-30X	5B-35	BR-235-35	235	470	435	575	700	825	170	120	290			
E	EGR-50X	5B-40	BR-175-40	175	350	375	425	575	675	185	125	310	210	150	360
F	EGR-50X	5B-40	BR-205-40	205	410	380	490	610	740	185	125	310	210	150	360
G	EGR-50X	5B-40	BR-235-40	235	470	435	575	700	825	185	125	310	210	150	360
H	EGR-70X	5B-45	BR-235-45	235	470	410	515	645	724	185	125	310	210	150	360
I	EGR-70X	6B-45	BR-205-45	205	410	380	490	610	740	185	125	310	210	150	360
J	EGR-70X	6B-45	BR-235-45	235	470	515	575	675	825	185	125	310	210	150	360
K	EGR-70X	6B-45	BR-265-45	265	530	440	635	735	885	185	125	310	210	150	360

○ 文化シャッター製品ラインナップ BUNKA Shutter product sample

スチールシャッター Steel Shutter



BSシェルター BS shelter



安心の文化シャッターが一貫してお届けしています。 Feel safety when using the products of BX BUNKA-VIETNAM

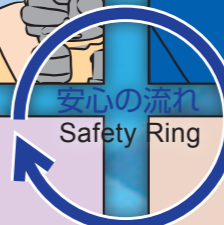
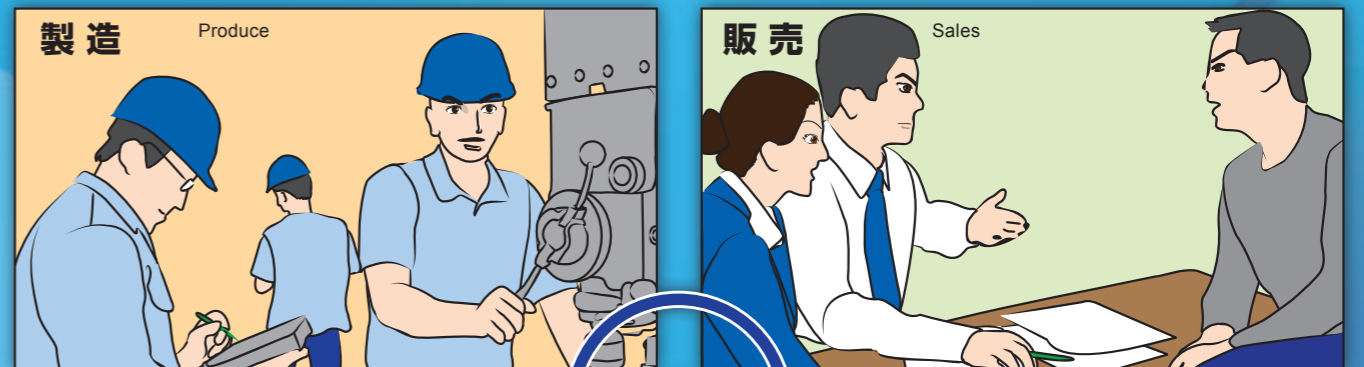

文化シッター

BX BUNKA VIETNAM Co., Ltd.

Head Office & Factory : Plot C9, Thang Long Industrial Park II, Yen My District, Hung Yen Province.

TEL: +84 3213 974 580 FAX: +84 3213 974 581

Website: <http://www.bunka.vn>

